

**User's**  
Manual

# VESTA HR

CROSS FLOW  
HEAT RECOVERY UNIT

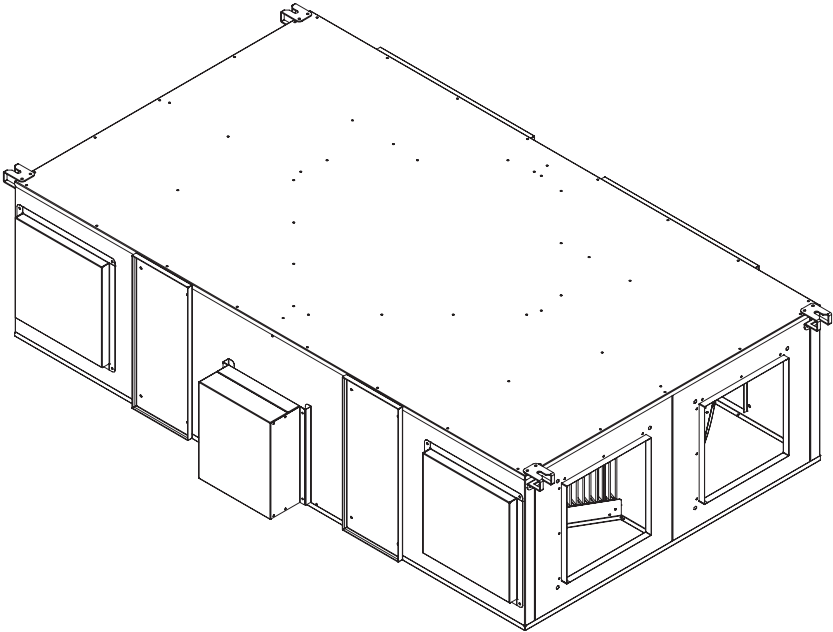



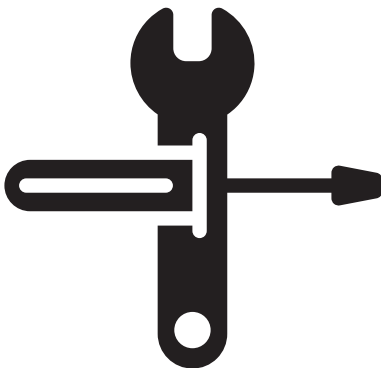

# CONTENTS

Safety .....	3
Control List .....	4
Vesta HR.....	5
Components .....	6
Technical Specifications.....	6
Dimensions .....	7
Transportation-Storage- Installation...	7
Vesta HR Wiring Diagrams .....	11
Controls.....	18
Maintenance .....	22
Troubleshooting.....	25
Warranty .....	26
Spare Part List .....	27
After Sales Services.....	28



# SAFETY

	<ul style="list-style-type: none"> <li>■ This product must not be disassembled under any circumstances. Only authorized repair technicians are qualified to conduct disassembly and repairs.</li> <li>■ Failure to heed this warning may result in fire, electrical shock or injury.</li> </ul>
	<ul style="list-style-type: none"> <li>■ Do not install this product in a refrigerated warehouse, heated swimming pool or other location where temperature and humidity are significantly different. (Failure to heed this warning may result in electrical shock or malfunctioning.)</li> <li>■ Do not install this product where it will be directly exposed to rain. (Failure to heed this warning may result in electrical shock or malfunctioning.)</li> <li>■ Do not install this product in a location where acid, alkali or organic solvent vapors, paints or other toxic gases, gases containing corrosive components or high concentrations of oily smoke are present. (Failure to heed this warning may result not only in malfunctioning but also fire, power leakage and electrical shock.)</li> <li>■ Do not use this product outside the range of its rated voltage and control capacity. Vesta HR 07 ~ Vesta HR 50; Single Phase (220-240 V, 50Hz), , Vesta HR 60 ;Three Phase (380-400 V, 50Hz). If electric heater is used Vesta HR 07 ~ Vesta HR 60 Three Phase (380 400V, 50 Hz.)</li> </ul>
	<ul style="list-style-type: none"> <li>■ Install this product in an environment where the temperature ranges from -10 °C to +40 °C and the relative humidity is less than 60%. If condensation is expected to form, heat up the fresh outside air by a duct heater etc. (the inability to take in fresh air into the desired properties may lead to a decrease in the amount of oxygen in the indoor environment and thus to disturbances)</li> <li>■ Select an adequately sturdy position for installing the product and install it properly and securely. (Injury may result if the product should fall.)</li> <li>■ Use the designated electrical wires for the control panel connections and connect the wires securely so that they will not be disconnected. (Failure to ensure proper connections may result in fire.)</li> <li>■ When passing metal ducts through wooden buildings clad with metal laths, wire laths or metal, these ducts must be installed in such a way that they will not make electrical contact with metal laths, wire laths or metal sheets. (Power leakage can cause ignition.)</li> <li>■ The outside ducts must be tilted at a gradient(3o or more) downwards toward the outdoor area from the main unit, and properly insulated. (The entry of rain water may cause power leaks, fire or damage to household property.)</li> <li>■ Gloves should be worn during installation. (Failure to heed this warning may result in injury.)</li> <li>■ A dedicated circuit breaker must be installed at the origin of mains power supply. This circuit breaker must be provided with a means for locking (lock and key).</li> <li>■ The body of the device, the room control panel and its cables must be at least 3 meters away from the high electromagnetic equipment or cables forming the area (Otherwise it may cause the device to malfunction or incorrect operation.)</li> </ul>
	<ul style="list-style-type: none"> <li>■ Connect the product properly to the ground. (Malfunctioning or power leaks can cause electrical shock.)</li> </ul>
	<ul style="list-style-type: none"> <li>■ An isolator switch having a minimum contact gap of 3 mm in all poles must be provided as a means of disconnecting the power supply.</li> </ul>

# CONTROL LIST

**1** Make sure the unit receives power and grounding is done!

---

**2** Make sure the length of electric cables is correct! (Check for overheating on cables!)

---

**3** Check if the cables heading to the electrical box are shielded (protected against magnetic field) and shield is grounded. If not, replace!

---

**4** Check if the exhaust and supply filters are clean and make sure they do not prevent air flow!

---

**5** Make sure the drain hose is connected and check for any blockages through the drain line!  
If needed, clean it!

---

**6** Please check that the duct dimensions used in the duct system are correct and of the same dimension of the units duct connection. If wrong correct it with appropriate one.

---

**7** Make sure electrical connections are done as it is described in this manual. Make necessary corrections if there is any faulty connection

---

**8** Make sure there is enough service space for installation. If not, repeat installation.

---

**9** In extremely cold climates in which freezing may occur on the heat recovery unit, use electric pre-heater at the fresh air suction to raise the air temperature to -8 °C or above.

---

**10** Check for unusual noise or vibration after the installation. If there is, control if anti-vibration pads are used.

VESTA HR units are designed to meet today's increasing energy efficiency demand using heat recovery and low electrical energy consumption. Units are built using high technology modern components optimized for market needs and running conditions.

VESTA devices are now responding with high heat recovery efficiency in ventilation and low electrical energy consumption to increased energy efficiency requirements. The devices are designed using modern components optimized for operating conditions and market needs.

High efficiency and low internal pressure drop heat recovery exchangers, ErP 2015 compliant plug fans, green building (LEED, BREEAM) compliant filters, durable and compact casing forms the main components of VESTA HR units. Standard control component SENSO controls not only ventilation, but also all other optional accessories such as heater/cooler.

## **VESTA HR units will;**

- 1.** Supply fresh air from outside.
- 2.** Extract stale inside air.
- 3.** Recover energy by heat transfer between extract and supply air.
- 4.** Increase quality of the intake air by filtration.
- 5.** Make sure the user can control the unit with all variable needs with standard control equipment.

# COMPONENTS

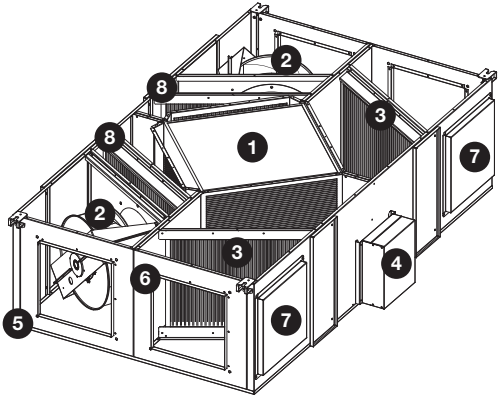

- 1 Heat Exchanger
- 2 Fan
- 3 Filter
- 4 E-Box
- 5 Casing
- 6 Duct Connections
- 7 Alternative Duct Connections
- 8 Optional Second Stage Filter

# TECHNICAL SPECIFICATIONS

Model		VESTA HR							
		07	12	15	20	30	40	50	60
Maximum Air Flow	m <sup>3</sup> /h	850	1350	1430	2320	3400	4300	5120	5800
Maximum Power Consumption	W	270	438	556	646	1080	1120	1300	1840
Maximum Current	A	1,20	1,80	2,40	2,90	4,60	4,80	5,40	3,80
Supply Voltage		230 V / 50 Hz / 1 ~							380 V / 50 Hz / 3 ~
Filter Class (Exhaust/Fresh Air)		G4/G4	G4/G4	G4/G4	G4/G4	G4/G4	G4/G4	G4/G4	G4/G4
Weight	Kg	60	75	88	110	140	170	190	205
Sound Pressure	DB	57	59	61	60	55	53	58	52

Sound values are measured for a ducted unit at 250Hz and 1,5m away from the unit.

The filter class is specified according to EN779: 2012 standard.

Air flows have been specified according to 0 Pa external static pressure

The technical table has been prepared according to the operating frequency of 50 Hz.

# DIMENSIONS

MODEL	DIMENSIONS					
	L	D	H	L2	D2	AxB
	mm					
7	1296	723	330	1331	625	200x200
12	1458	824	390	1494	726	250x250
15	1458	824	439	1494	726	250x250
20	1820	1086	509	1856	988	300x300
30	1970	1186	559	2006	1088	350x350
40	2182	1238	630	2182	1140	400x400
50	2282	1238	660	2318	1140	450x475
60	2282	1338	699	2318	1240	450x540

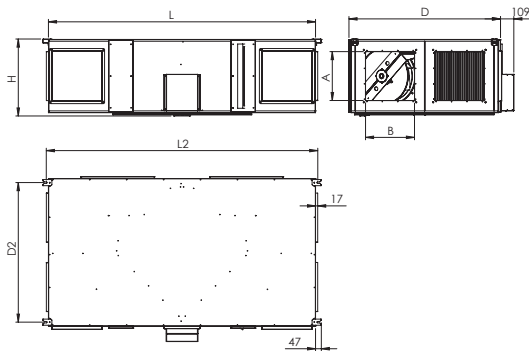

## TRANSPORTATION-STORAGE- INSTALLATION

### a) Transportation

All heat recovery devices manufactured by AERA are passed through all tests and controls and shipped from the factory. Appropriate lifting methods should be used to prevent damage to the heat recovery devices during vertical or horizontal transportation. Transpallets or forklifts can be used to carry and lift these devices. During lifting and transportation, the appliance must be secured and safety measures must be taken for safety. Lifting and carrying should be done by trained and experienced personnel. Ensure that the weight is uniformly distributed across the four corners during carry of the devices.



# TRANSPORTATION-STORAGE- INSTALLATION

## b) Storage

All heat recovery devices manufactured by AERA are located in a place after shipment. If storage is required, close all openings to avoid contamination. The environment in which the heat recovery device is stored should have a minimum temperature of  $-20^{\circ}\text{C}$ , a maximum temperature of  $+40^{\circ}\text{C}$  and a maximum of 80% relative humidity. It must be stored in a closed box away from dust and moisture to avoid damaging the devices. Prevent the electrical components and components from being damaged when performing the packaging of the device. Accessories such as filters, must be packaged separately to avoid exposure to dust and moisture.



## c) Installation

During installation, check the weight and dimensions of the ceiling-mounted heat recovery equipment reported by AERA, as appropriate to the location where the appliance is to be installed and transported. During installation of the device, for the service of filters; the service space area must be at least the values indicated on the minimum table. Also, in order to be able to change and maintain the heat recovery exchanger, the service door under the device must be opened. So service space should be as long as the length of the exchanger.

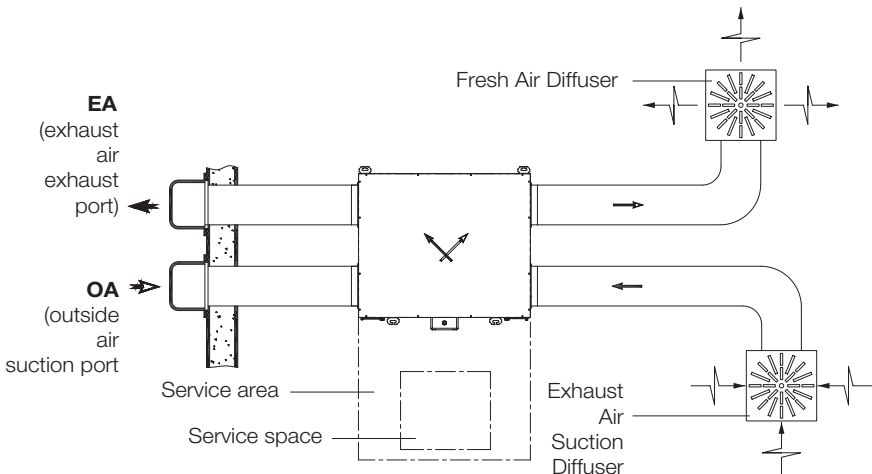



# TRANSPORTATION-STORAGE- INSTALLATION

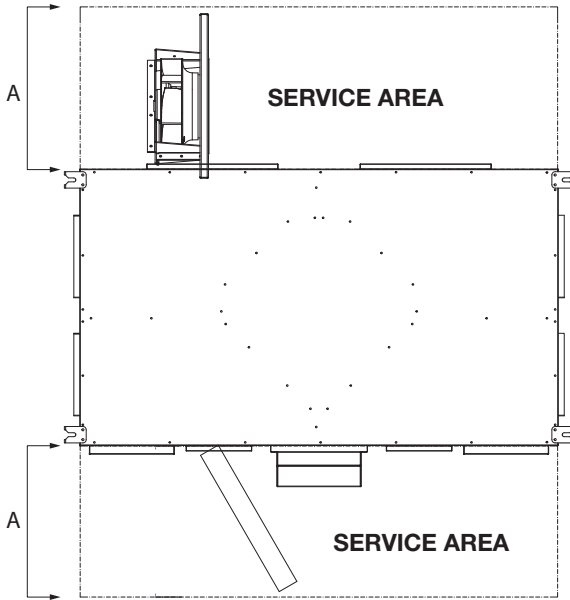

		DIMENSIONS
MODEL		A
		mm
VESTA HR	7	355
	12	410
	15	460
	20	510
	30	560
	40	600
	50	600
60	660	



Check for warnings before mounting the devices in the duct system

Steep turn



Multiple elbows



Elbow after unit



Sudden contraction and/or expansions in duct diameter

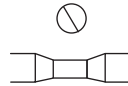

# TRANSPORTATION-STORAGE- INSTALLATION

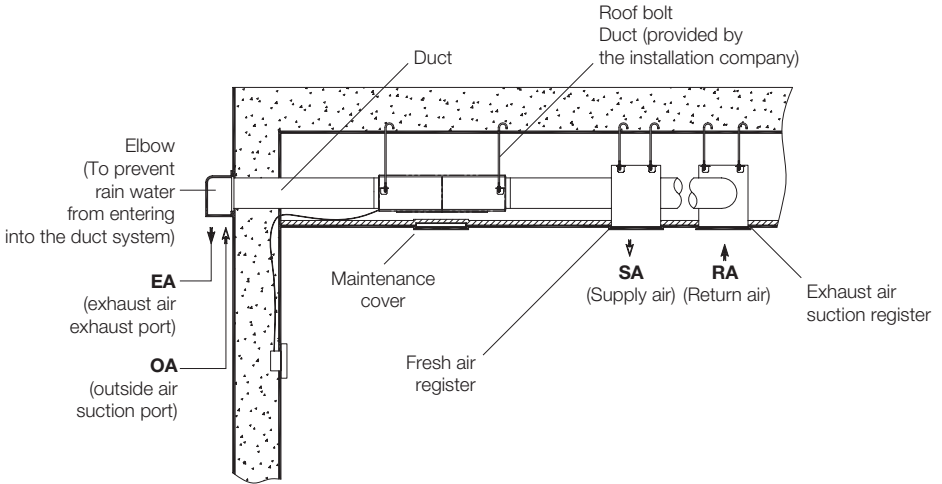

**WARNING** Install the drain plug on the side of the fresh air.

**WARNING** Check the strength of the stems during assembly.

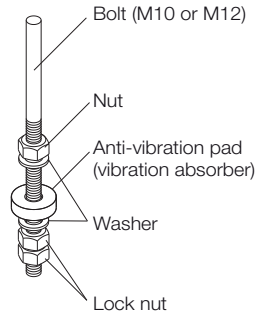
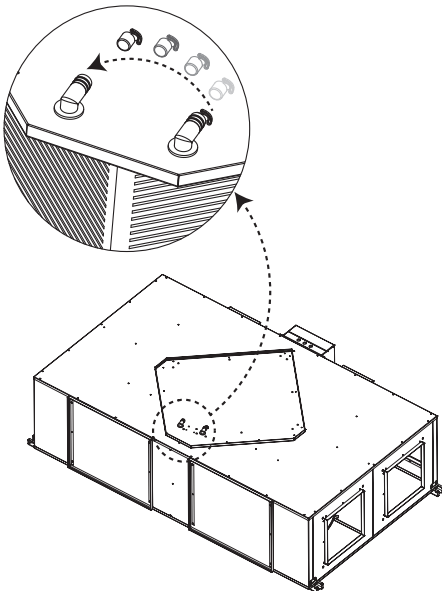

# VESTA HR WIRING DIAGRAM

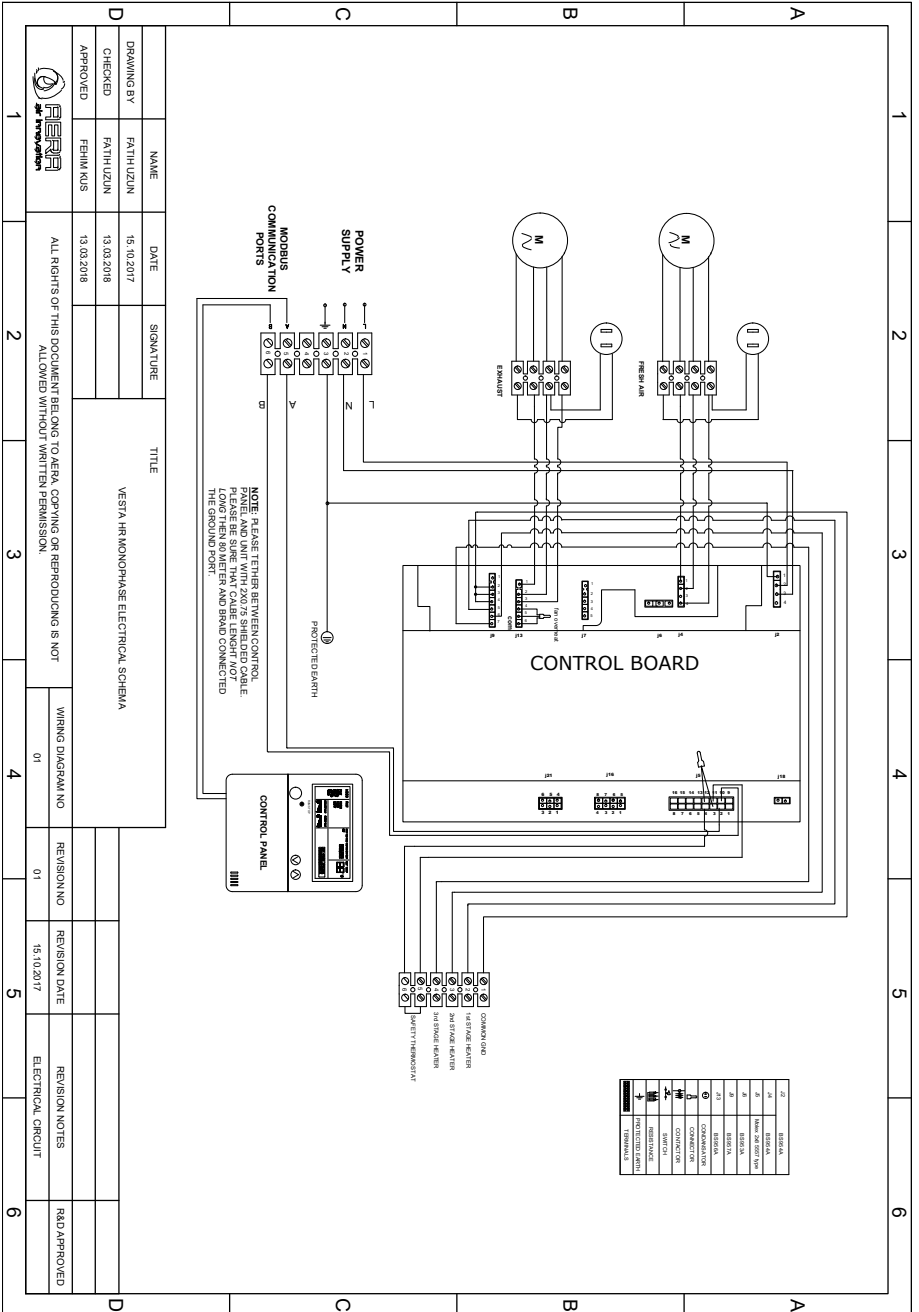

NAME	DATE	SIGNATURE	TITLE
DRAWING BY FATIH UZUN	15.10.2017		VESTA HR MONOPHASE ELECTRICAL SCHEMA
CHECKED FATIH UZUN	13.03.2018		
APPROVED FERIM KUSIS	13.03.2018		

ALL RIGHTS OF THIS DOCUMENT BELONG TO AERA. COPYING OR REPRODUCING IS NOT ALLOWED WITHOUT WRITTEN PERMISSION.			
WIRING DIAGRAM NO	01	REVISION NO	01
REVISION DATE	15.10.2017	REVISION NOTES	ELECTRICAL CIRCUIT
R&D/APPROVED			

REV	REVISION
01	INITIAL
02	CHANGE AND IMPROVE
03	REVISION
04	REVISION
05	REVISION
06	REVISION
07	REVISION
08	REVISION
09	REVISION
10	REVISION

# VESTA HR WIRING DIAGRAM



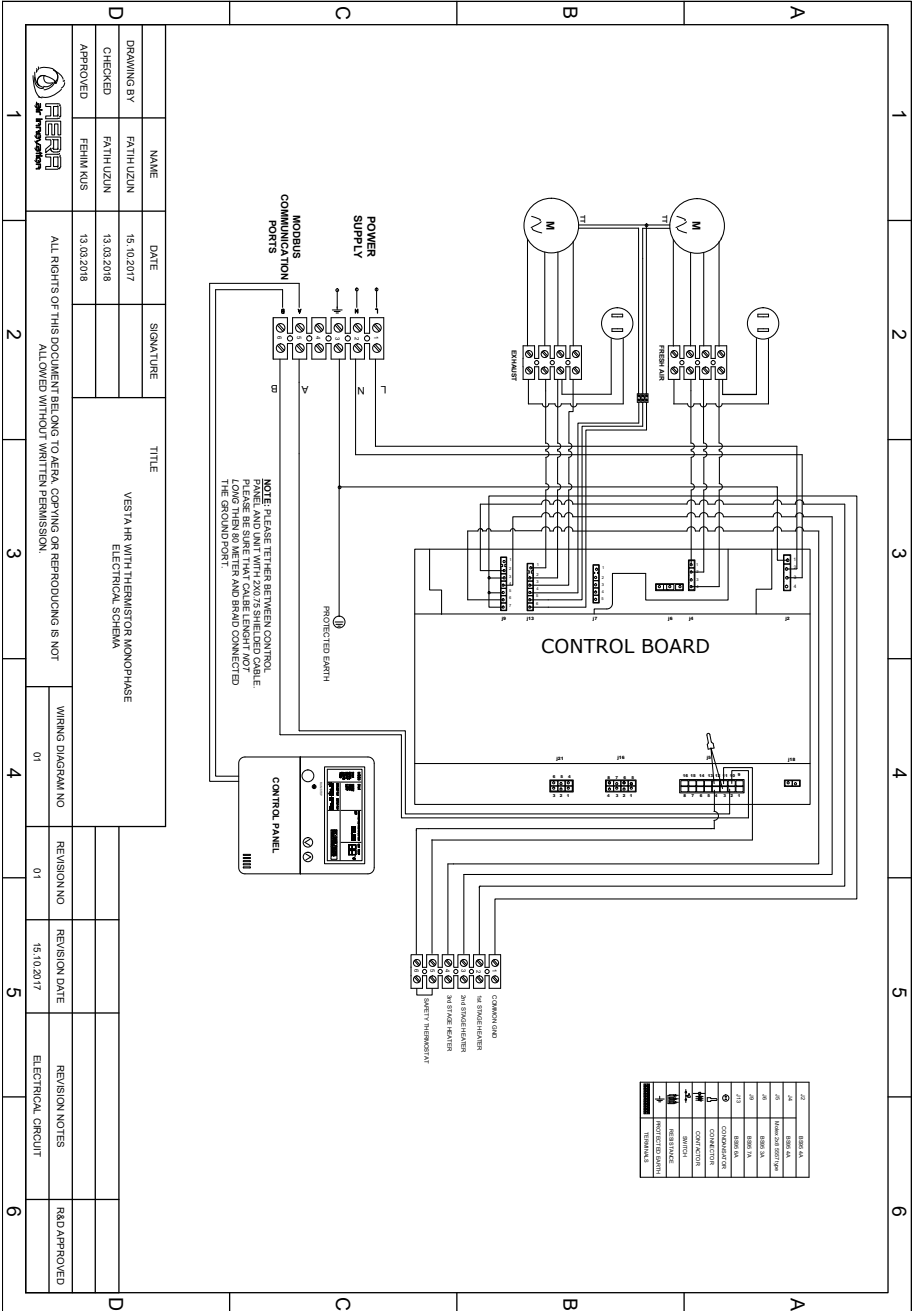

NAME	DATE	SIGNATURE	TITLE
FATHI UZUN	15.10.2017		VESTA HR WITH THERMOSTAT NON-PHASE ELECTRICAL SCHEMA
FATHI UZUN	13.03.2018		
FETHI AKIS	13.03.2018		

ALL RIGHTS OF THIS DOCUMENT BELONG TO AKERA. COPYING OR REPRODUCING IS NOT ALLOWED WITHOUT WRITTEN PERMISSION.	WIRING DIAGRAM NO	01	REVISION NO	01	REVISION DATE	15.10.2017	REVISION NOTES	ELECTRICAL CIRCUIT	R&D/APPROVED
--	-------------------	----	-------------	----	---------------	------------	----------------	--------------------	--------------

# VESTA HR WIRING DIAGRAM

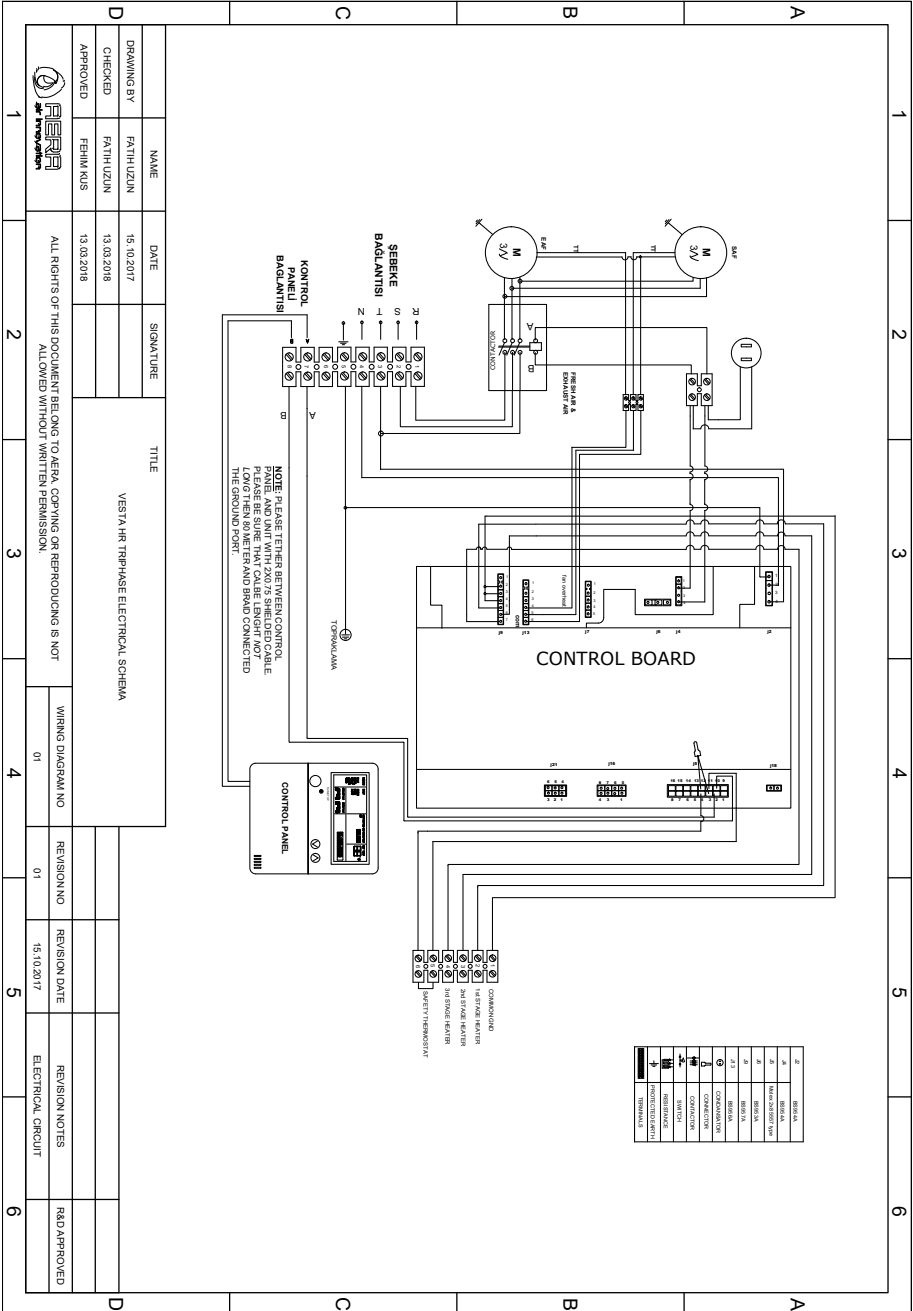

NAME	DATE	SIGNATURE	TITLE
DRAWING BY FATİH UZUN	15.10.2017		VESTA HR TRIPHASE ELECTRICAL SCHEMA
CHECKED FATİH UZUN	13.03.2018		
APPROVED FERİH KÜS	13.03.2018		
			
ALL RIGHTS OF THIS DOCUMENT BELONG TO AERA. COPYING OR REPRODUCING IS NOT ALLOWED WITHOUT WRITTEN PERMISSION.			
WIRING DIAGRAM NO	01	REVISION NO	01
REVISION DATE	15.10.2017	REVISION NOTES	ELECTRICAL CIRCUIT
R&D/ APPROVED			



# VESTA HR WIRING DIAGRAM WITH ELECTRICAL HEATER

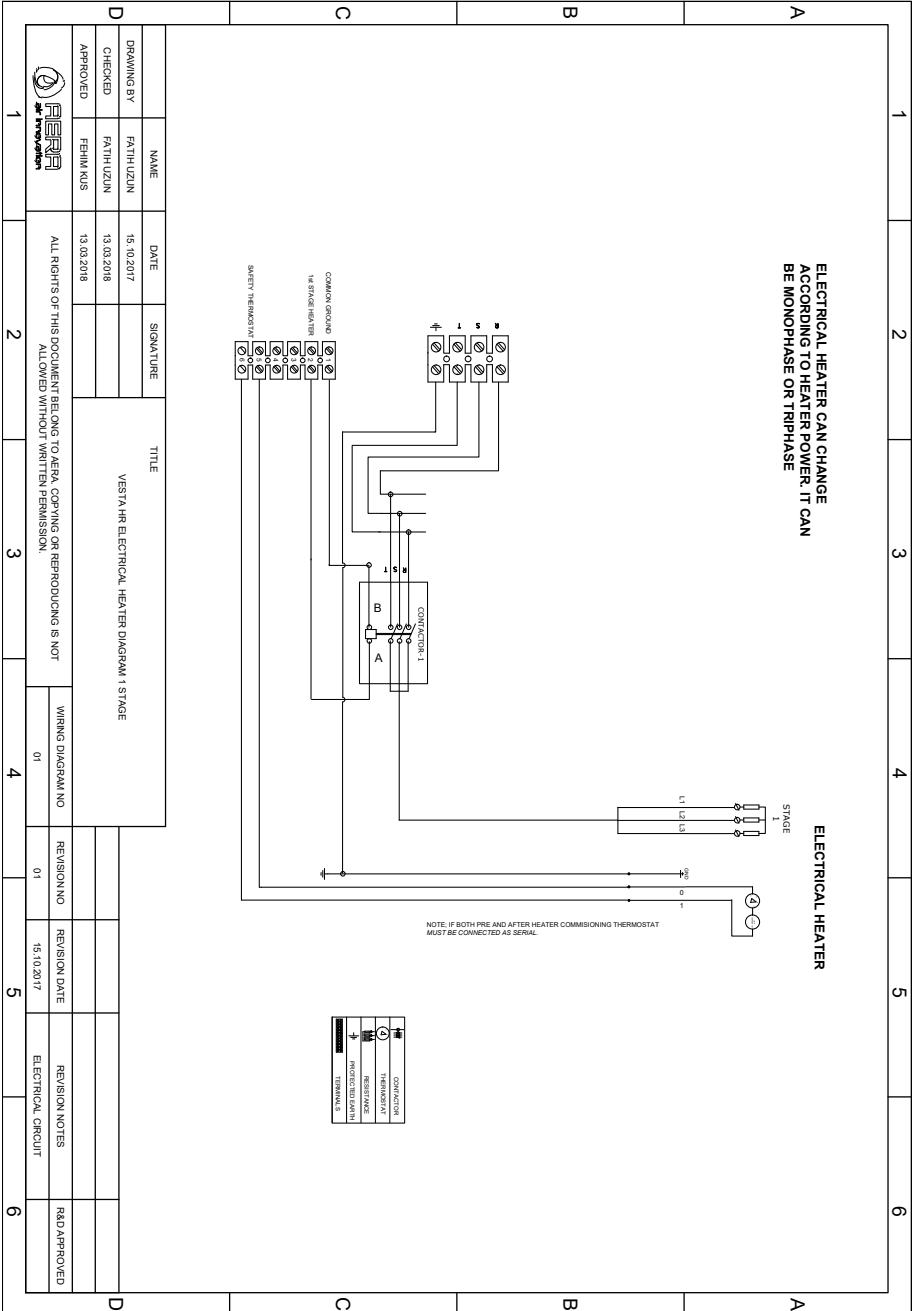

NAME	DATE	SIGNATURE	TITLE
FATIH UZUN	15.10.2017		VESTA HR ELECTRICAL HEATER DIAGRAM 1 STAGE
FATIH UZUN	13.03.2018		
FERHAN KUS	13.03.2018		

  

	ALL RIGHTS OF THIS DOCUMENT BELONG TO AERA. COPYING OR REPRODUCTIONS IS NOT ALLOWED WITHOUT WRITTEN PERMISSION.
--	---

WIRING DIAGRAM NO	01
REVISION NO	01
REVISION DATE	15.10.2017
REVISION NOTES	ELECTRICAL CIRCUIT
R&D APPROVED	

# VESTA HR WIRING DIAGRAM WITH ELECTRICAL HEATER

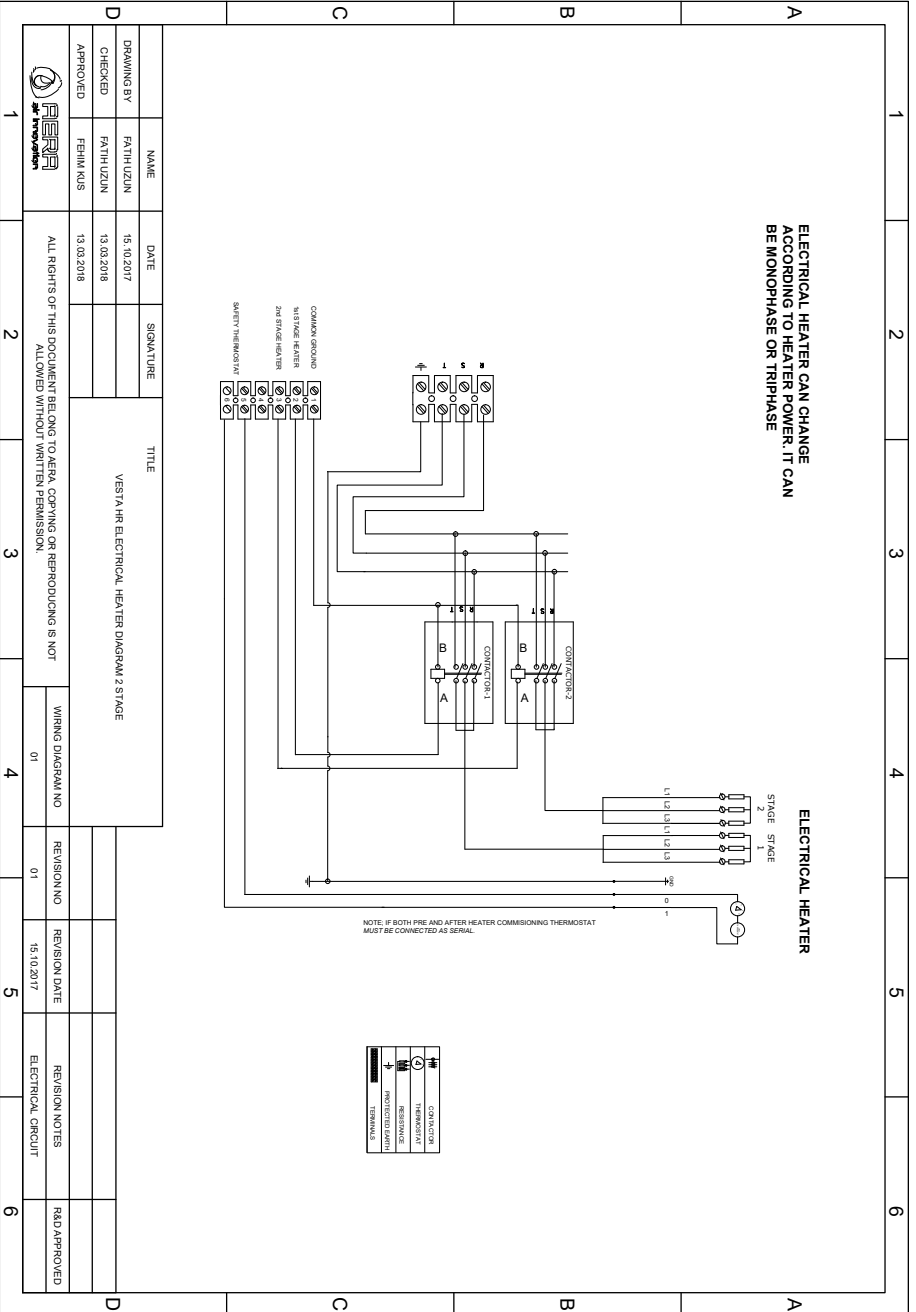

NAME	DATE	SIGNATURE	TITLE
DRAWING BY FATIH UZUN	15.10.2017		VESTA HR ELECTRICAL HEATER DIAGRAM 2 STAGE
CHECKED FATIH UZUN	13.03.2018		
APPROVED FERHM KUS	13.03.2018		

  

WIRING DIAGRAM NO	REVISION NO	REVISION DATE	REVISION NOTES	R&D APPROVED
01	01	15.10.2017	ELECTRICAL CIRCUIT	

ALL RIGHTS OF THIS DOCUMENT BELONG TO AKERA. COPYING OR REPRODUCING IS NOT ALLOWED WITHOUT WRITTEN PERMISSION.



# VESTA HR WIRING DIAGRAM WITH ELECTRICAL HEATER

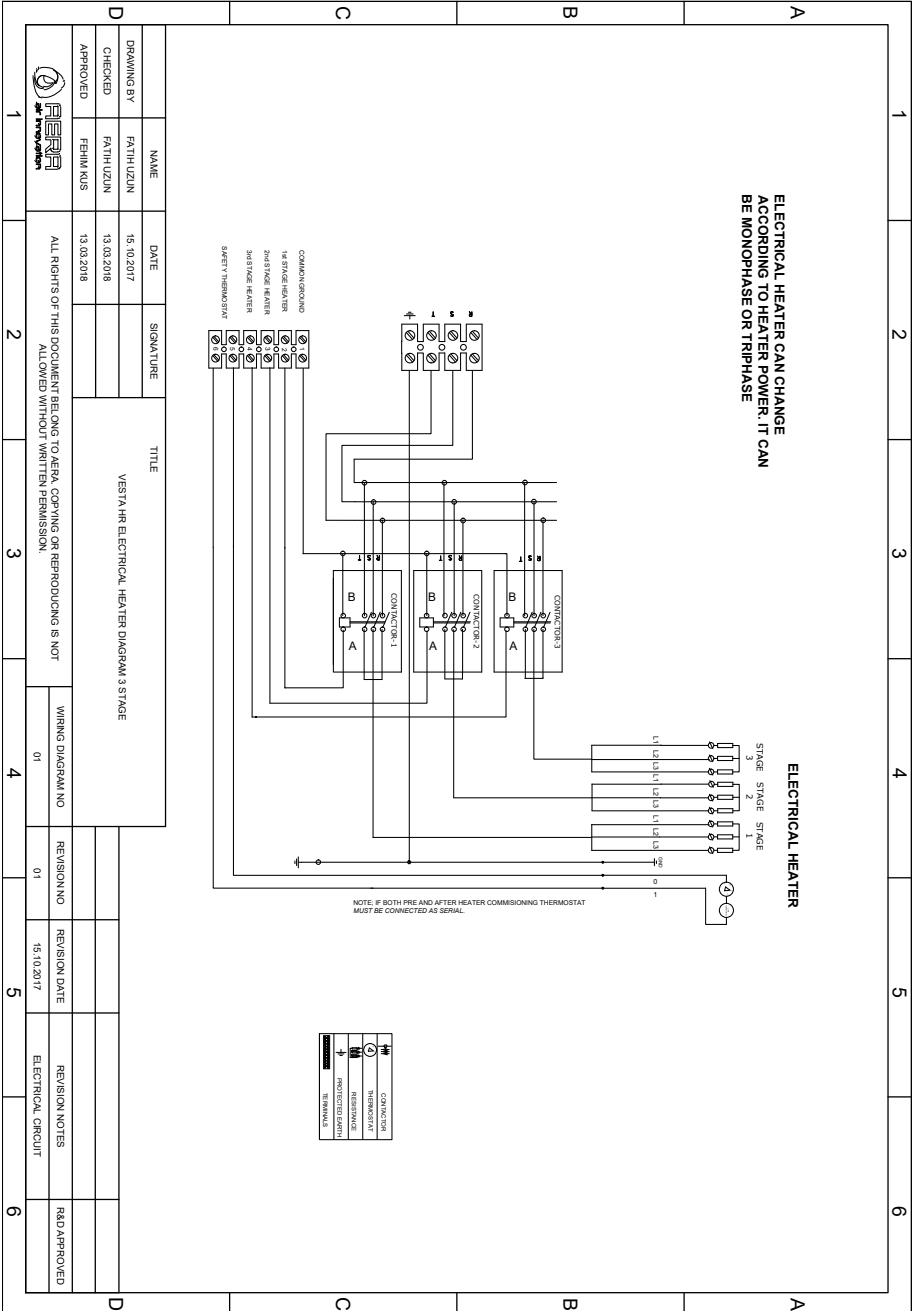

NAME	DATE	SIGNATURE	TITLE
FATIH UZUN	15.10.2017		VESTA HR ELECTRICAL HEATER DIAGRAM & STAGE
FATIH UZUN	13.03.2018		
FERHAN KUS	13.03.2018		

WIRING DIAGRAM NO	REVISION NO	REVISION DATE	REVISION NOTES	R&D APPROVED
01	01	15.10.2017		

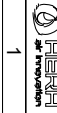

# VESTA HR WIRING DIAGRAM WITH ELECTRICAL HEATER

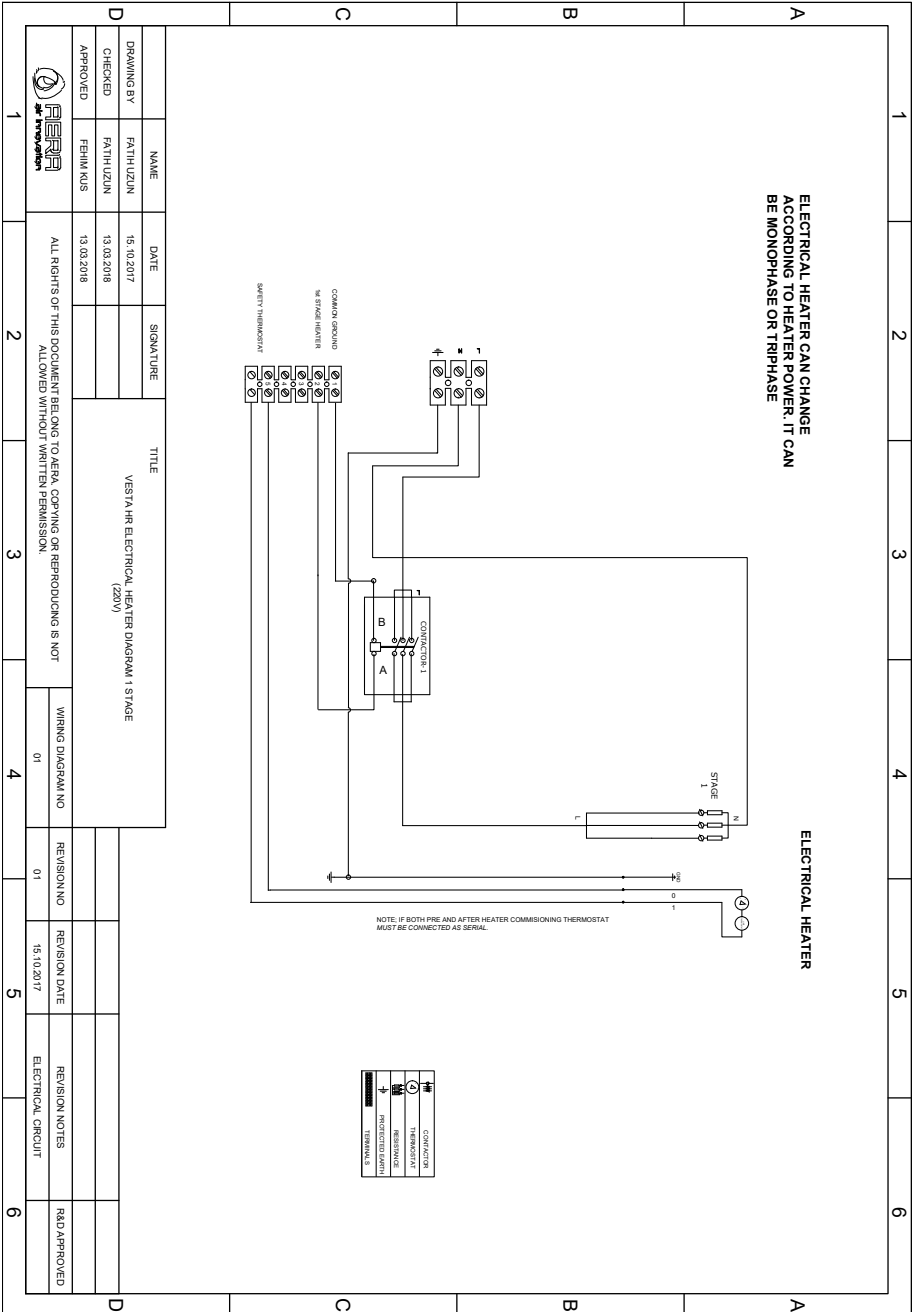

# CONTROLS

## ► Button Functions

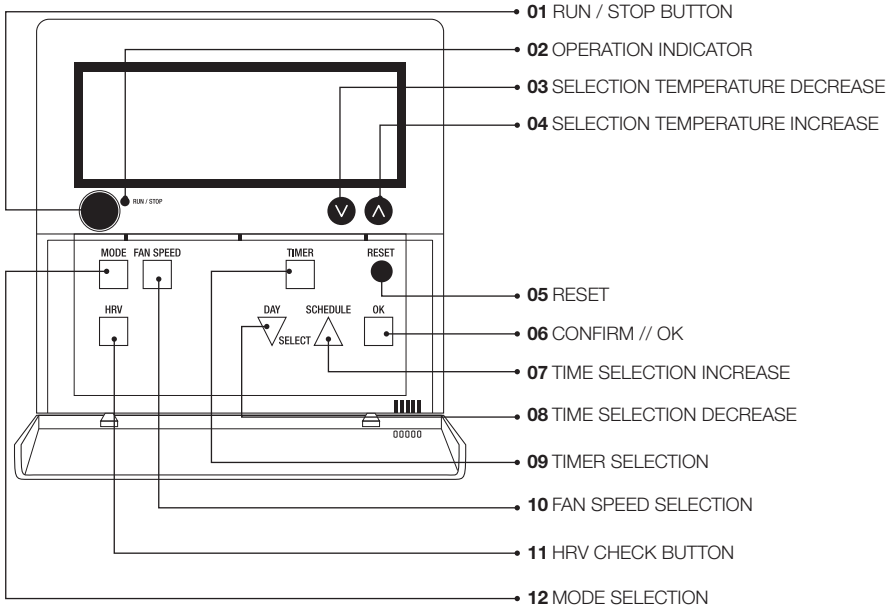

## ► LCD Functions

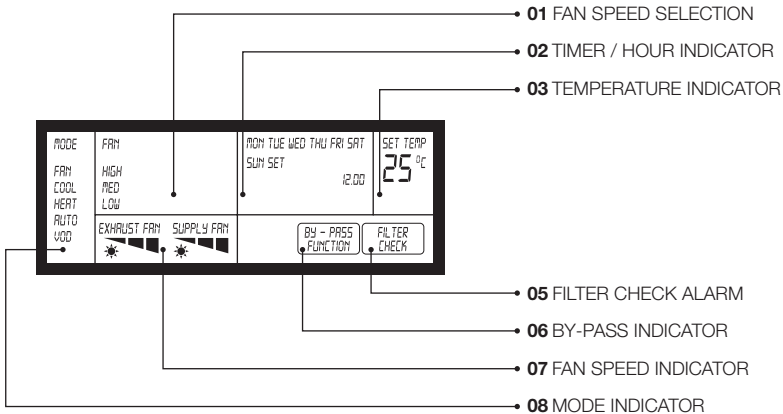

## Remote Control Functions

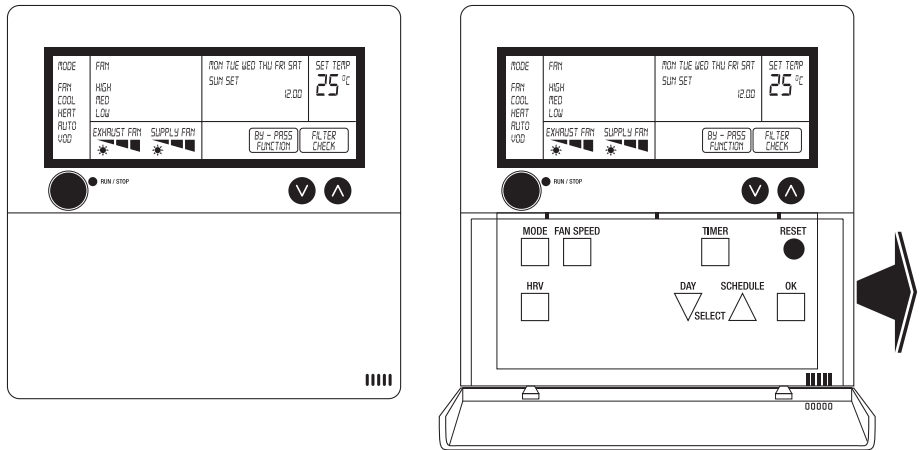

### RUN / STOP

When the backlight and led is off, press the button once to turn the unit on. When the unit is “on” press on/off 2 seconds to switch it off



Increase/decrease set point room temperature (SET TEMP is on)

### MODE

Press to select the listed modes of operation (FAN, COOL, HEAT, AUTO, VOD). Every time a button is pressed a next mode lights up. After a 5 seconds delay the mode will be activated. The text MODE on display is always visible.

### FAN

With this button the fan speed of the

- Pressing once: text FAN lights up. “EXHAUST FAN” and current fan speed (text) starts blinking
- Use buttons to select fan speed (high, med, low)
- Press OK to confirm
- “SUPPLY FAN” and current fan speed (text) starts blinking
- Use buttons to select fan speed (high, med, low)
- Press OK to confirm
- Text FAN and HIGH, MED, LOW lights up

### TIMER

Press to set timer function on/off. When “on” the display shows SET

### RESET

Press to reset filter check. When “on” the display shows FILTER CHECK. Default Filter Check the value in use in parameter list 2.3.3.

# CONTROLS

## LCD Functions





### CHANGE TIME

- Press OK button for 3 seconds, time starts blinking.
- Change time with ▲▼ buttons. Time starts to change faster are pressed for a while.
- Press OK to confirm, current day starts blinking.
- Change day with ▲▼ buttons.
- Press OK to confirm

Press RUN / STOP to stop immediately and go back to normal operation

### TIMER FUNCTION

The timer function can be used to program block times in which the unit is operating. Outside the blocks the unit is off. The timer function makes it possible to program 2 on/off times per day.

- Press TIMER button for 3 seconds, day MON starts blinking, all other LCD segments are off
- Press DAY button (one or more times) to select the day to be set
- Press OK to confirm, the selected day is permanent on
- The temp display shows  which means timer block 1 "on" time can be programmed
- Adjust the "on" time with the DAY and SCHEDULE buttons, press OK to confirm
- Next the timer block 1 "off" time can be programmed, the temp display shows 
- Again adjust the "off" time with the DAY and SCHEDULE buttons, press OK to confirm
- Next the timer block 2 "on" time can be programmed, the temp display shows 
- Adjust the "on" time with the DAY and SCHEDULE buttons, press OK to confirm
- The temp display shows  which means timer block 2 "off" time can be programmed
- Again adjust the "off" time with the DAY and SCHEDULE buttons, press OK to confirm
- Now the next day starts blinking and can be programmed accordingly as described above.
- To exit the programming mode press OK for 3 second or wait 1 minute

### ADDITIONAL FEATURES

- A specific "on" or "off" time can be deleted by pressing RESET when programming the time block. If deleted the time display shows:  and the time is not used.
- When for example the unit is "on" on Monday and no "off" time is programmed that day anymore, the unit remains "on" until the first "off" time is reached the next day(s). The same sequence is used when the unit would be "off"

# CONTROLS

## Example 1 – Normal Blocks

MON

Time display

Temp Display



1<sup>st</sup> “on” time - unit starts on Monday at 8:00



1<sup>st</sup> “off” time - unit starts on Monday at 12:00



2<sup>nd</sup> “on” time - unit starts on Monday at 14:00



2<sup>nd</sup> “off” time - unit stops on Monday at 18:00

## Example 2 – Overlapping Blocks

MON

Time display

Temp Display



1. 1<sup>st</sup> “on” time - unit starts on Monday at 8:00



1. 1<sup>st</sup> “off” time - unit stops on Monday at 12:00



2<sup>nd</sup> “on” time – No action

Time programmed before 1<sup>st</sup> stop time, unit remains off



2<sup>nd</sup> “off” time - unit stops on Monday at 18:00

Time programmed before 1<sup>st</sup> stop time, unit remains off

## Example 2 – Overlapping Blocks

MON

Time display

Temp Display



1. 1<sup>st</sup> “on” time - unit starts on Monday at 8:00



1. 1<sup>st</sup> “off” time - unit stops on Monday at 12:00



2<sup>nd</sup> “on” time – No action



2<sup>nd</sup> “off” time - unit stops on Monday at 18:00

# MAINTENANCE

The maintenance interval specified in this guideline is normally concerned with the transport of contaminated air. If the device is operating in excessively dirty airflows, the maintenance intervals must be reduced accordingly. Before starting any maintenance work, the device must be stopped correctly and all poles must be disconnected from the mains.

- i. Stop the device using remote access. First, fully active programs should be disabled.
- ii. Wait for the damper to close and the fans to stop.
- iii. Set the operation switch to the off position and make sure it will not open accidentally. The electrical connection must be disconnected for maintenance of the E-Box
- iv. Wait for the voltage to decrease.
- v. If there is a heater, wait for the heater to cool.
- vi. You can open the maintenance doors.



**Beware that optional channel type water heater coils are protected against to restart of the water circulation.**

Before all periodic maintenance, the device must be switched off and you should wait at least two minutes for the fans stop.

- The condensation pan and drainage outlet should be checked every three months. It should be cleaned if necessary.
- Filters should be checked every three months against to filter pollution and damage. It should be changed if necessary.
- The fan and motor should be checked every three months for dirt, mechanical damage, corrosion and the suitability of the connections.
- The suitability of the fan balance should be checked every three months.
- An amperage measurement should be made once a year for the risk of electric leakage and high amperage.
- Elektrik ekipmanları kir, mekanik hasarlar, korozyon ve bağlantılarının uygun olup olmadığı açısından üç ayda bir kontrol edilmelidir.
- The E-Box on the device should be cleaned dry if necessary, and absolutely no water should be used.
- The power supply should be checked every three months.
- If it must be cleaned, it must be cleaned in accordance with the maintenance instructions.
- Against rusting, rotting and wearing, service covers should be removed once a year to check the device

# MAINTENANCE

## Cleaning of The Heat Recovery Exchanger

### 1. Step

loosen screws to remove service doors When performing this operation, make sure that the heat exchanger does not turn down.



**During heat exchanger maintenance, support the heat exchanger so that it does not fall off when opening the service doors.**

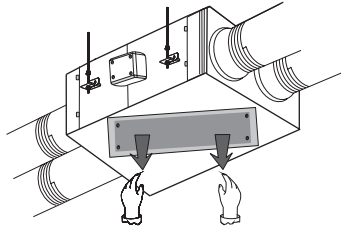

### 2. Step

Clean the heat recovery exchanger with hot water or steam. Use natural detergent or soap powder if need be. Leave it to dry after cleaning and mount it to the unit after it is completely dry. Tighten the service cover screws thoroughly and make sure the heat recovery exchanger does not fall down.

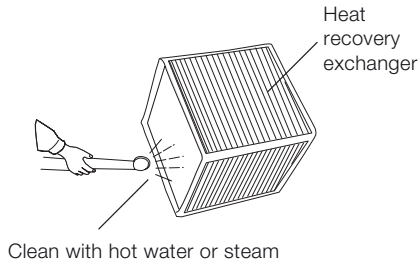



# MAINTENANCE

## b) Cleaning of The Filters

### 1. Step

Remove the filters from the device by opening the filter service doors.

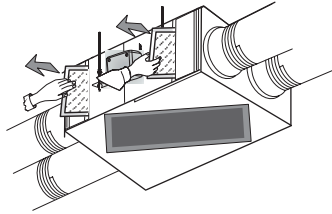

### 2. Step

Use a vacuum cleaner to remove the dust from the surface. To remove heavy soils, dissolve the natural detergent or soap powder in cold water, press the filter into the solution you prepared, and let go out to dry. Never apply force on filter material. Once you're sure you're dry, put it on the device and close the service door and tighten the screws

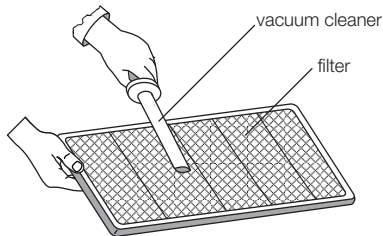

# TROUBLESHOOTING

FAULT	REASON	SOLUTION
<b>FANS DO NOT WORK</b>	<b>a.</b> Power supply off	<b>a.</b> Turn on the power supply
	<b>b.</b> No signal from the control panel	<b>b.</b> Press the correct buttons of the control panel
	<b>c.</b> Incorrect or loose electrical connection	<b>c.</b> Connect connections correctly
	<b>d.</b> Motors in thermal protection mode	<b>d.</b> Check motor current
	<b>*e.</b> No signal from the frequency inverter	<b>*e.</b> Check the error code on the frequency inverter's screen
<b>FANS RETURN TO REVERSE DIRECTION</b>	<b>a.</b> Phase connection is not correct	<b>a.</b> Make the correct phase connection
<b>LOW AIR FLOW</b>	<b>A.</b> filters clogged or dirty	<b>a.</b> Change or clean filters
	<b>b.</b> Air duct is clogged	<b>b.</b> Check the air ducts
	<b>c.</b> Channel connections are incomplete.	<b>c.</b> Check the duct system for leaks and complete the connections
<b>HIGH AIR FLOW</b>	<b>A.</b> Channel connections are incomplete.	<b>a.</b> Check the duct system for leaks and complete the connections
	<b>b.</b> Supply voltage is low	<b>b.</b> Measure the current drawn by the motor against overloading
	<b>c.</b> Grilles are not mounted	<b>c.</b> Mount the grilles
	<b>d.</b> Filters are not mounted	<b>d.</b> Mount the filters
<b>DRAINAGE WATER CAN NOT BE DISCHARGED</b>	<b>A.</b> Drainage plugged	<b>a.</b> Clean drain pipe
	<b>b.</b> Incorrect installation of drainage pipe.	<b>b.</b> Mount the drain pipe correctly

**\*Frequency inverters are accessory (Not included in standart equipment).**

# WARRANTY

This device is designed to operate efficiently and safely in the event that they are installed in accordance with the instructions in the operating instructions, and the operating and maintenance requirements are fully met. All maintenance procedures required for the device must be carried out by experts and authorized persons.

## Warranty Conditions

- The devices are warranted against defects in material and workmanship for two (2) years.
- During the warranty period of the device, due to material and manufacturing mistakes in the event of a malfunction, the following conditions will not be charged;
  - a. Labor costs
  - b. Change value of the parts
- The user should report within 8 days of production defects or defects, in terms of the validity of the warranty, immediately upon the detection of defects, device will be stopped
- As explained in the instruction for use and maintenance, the warranty is valid as long as the devices are periodically maintained.
- Consumables that are periodically changed during the warranty period must be originally supplied from AERA.
- Warranty does not apply to consumables, eg filters.

## Issues to be Considered by Customers Related to Warranty

The AERA service personnel or the services authorized by AERA should intervene for the devices covered by the warranty. Damage caused by installation mistakes or by unauthorized persons is not covered by the warranty.

The following conditions are not covered by warranty:

- Damage due to transportation and improper placement
- Damage caused by operating the device outside the operating conditions
- Damage caused by the use of spare parts not approved by the manufacturer
- Damage due to improper electrical connections, connection other than that specified on the electrical diagram label

# WARRANTY

- Damage and failures due to factors such as impact, breaking, scratching and freezing.
- Faults that may arise from irregularities in the electrical supply where the device is installed
- Damage caused by failure to make drainage pipe and to be corrosion inside the device
- Damage that may be caused by the corrosive and acidic effect of the environment in which the device will operate
- Damages caused by foreign materials forgotten in the device or fan motor
- Damage caused by not using flexible connection in channel connections
- Damages caused by failure to observe the points specified in this user manual

## SPARE PART LISTS

- I.** FANS
- II.** HEAT RECOVERY EXCHANGER
- III.** FILTERS
- IV.** CONTROL PANEL

# AFTER SALES SERVICES

AERA heat recovery devices do not have any parts replacement or repair work to be performed by the user other than cleaning and eye inspection. Users should contact the AERA company for faults detected during operation or maintenance. If you have problems and need to get a service, please contact the following address.



---

## FACTORY

\*\*\*

3. Cadde No:13 Pancar OSB, Torbalı - İzmir  
TEL +90 232 799 0 111 FAKS +90 232 799 01 14

**User's**  
Manual

# VESTA HR

CROSS FLOW  
HEAT RECOVERY UNIT

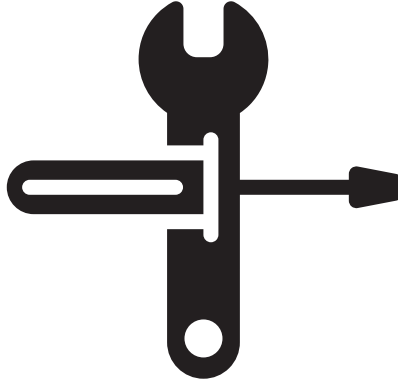

**AERA AIR CONDITIONING & VENTILATION TECH.**

**Sales Office** ■ Varyap Meridian, Grand Tower A Blok No:130 Ataşehir İSTANBUL  
TEL +90 216 504 76 86 FAX +90 216 504 76 90

**Factory** ■ 3. Cadde No:13 Pancar OSB, Torbalı - İzmir  
TEL +90 232 799 0 111 FAX +90 232 799 01 14

[aera.com.tr](http://aera.com.tr)

